

REWORK OF COMPRESSOR FROM EXTERNALLY TO INTERNALLY REGULATED FOR OPEL ASTRA H

In case of replacement the compressor of AC system has to be replaced by an internally regulated compressor, install a cable bridge and an additional cable.

Use the actually circuit diagram to rework the electrical system.

Working procedure:

1. Disconnect battery.
2. Replace compressor.
3. Remove engine compartment electronic module (UEC).

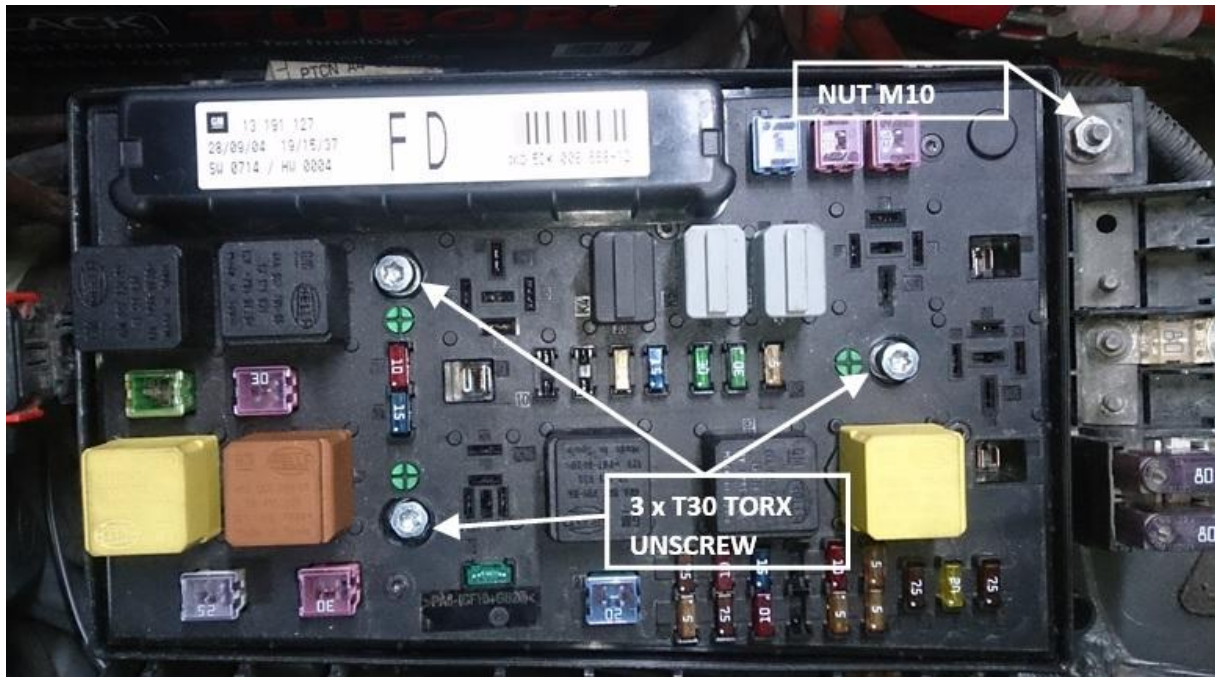

4. Clip-off wiring harness plug XE2.

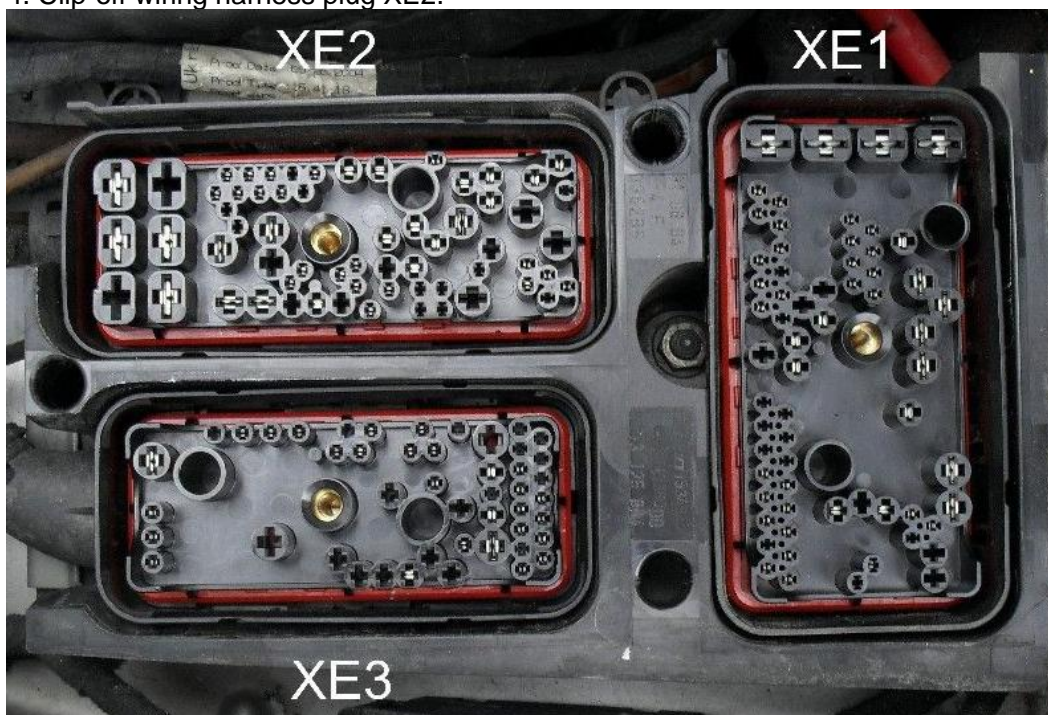

5. Check wiring harness plug.

Note

If a cable bridge is installed between chamber 52 and chamber 53, go on as of step 8.

6. Install cable bridge into wiring harness plug XE2 (Picture 1).

- unlatch protection in direction of arrow
- remove seals with a suitable tool
- install cable bridge brown/black into chamber 52 terminal with grey seal and chamber 53 with blue seal
- latch harness plug

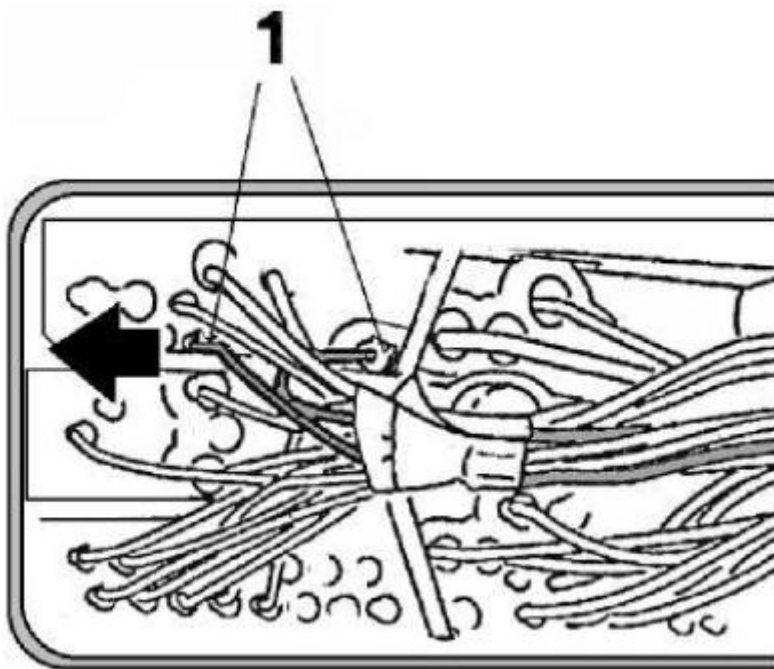

Picture 1



7. Clip-in wiring harness plug XE2.
8. Clip-off wiring harness plug XE1.
9. Install cable black/white into wiring harness plug XE1 (Picture 2)

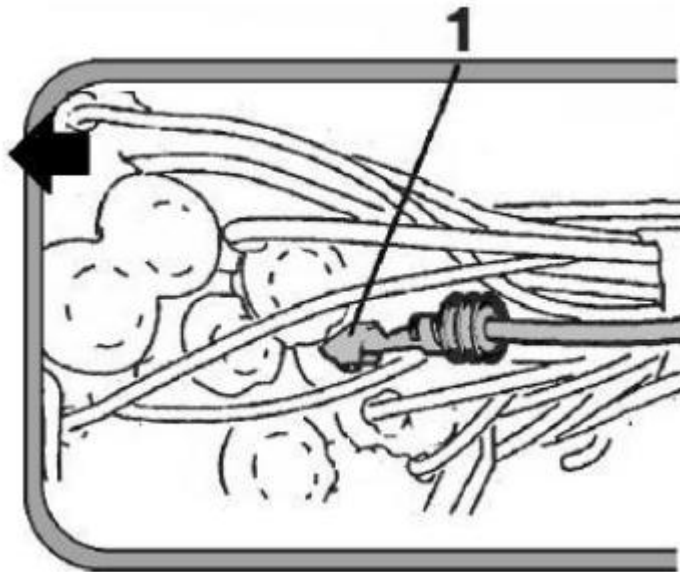

Picture 2

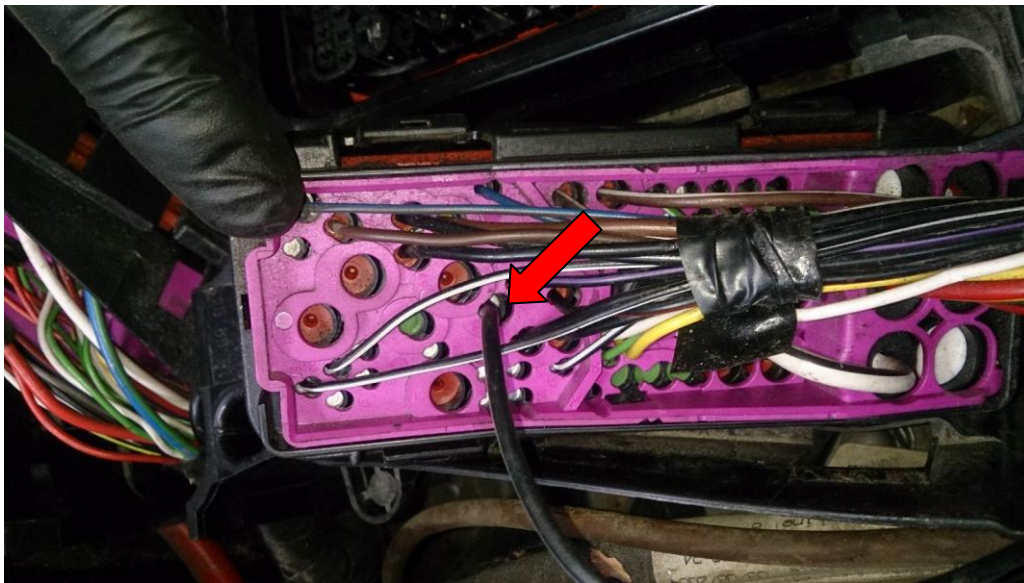

- unlatch protection in direction of arrow
- remove seal with a suitable tool
- install terminal (female) into chamber 44, pay attention to installation position
- latch wiring harness plug.

10. Clip-in wiring harness plug XE1.
11. Route cable along the wiring harness to plug X26 and fasten with insulating tape.
12. Remove front wheel.
13. Remove wheel housing protective paneling.
14. Clip-off wiring harness plug X26 from bracket.
15. Unlatch and disconnect wiring harness plug X26 (Picture 3)

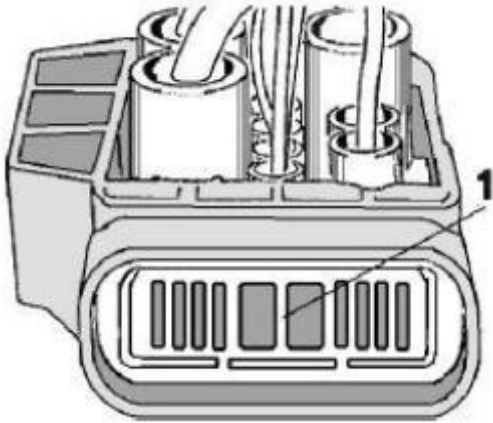

Picture 3

- remove cable strap
- remove lock latching (1)

16. Remove terminals from chamber 1 and chamber 2 (Picture 4)

- press out terminals
- cut-off terminals
- insulate cable ends and fasten to wiring harness with insulating tape.

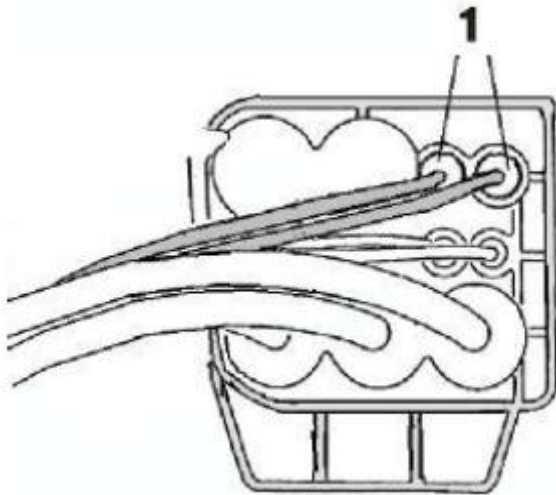

Picture 4

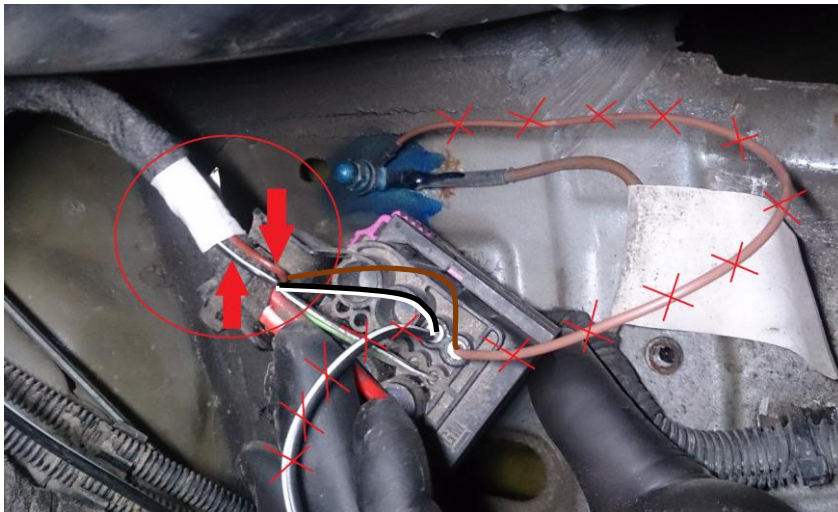

17. Install terminal of cable black/white from wiring harness plug XE1 (chamber 44) into wiring harness plug X26 as well as terminal of brown cable and install lock latching (Picture 5).

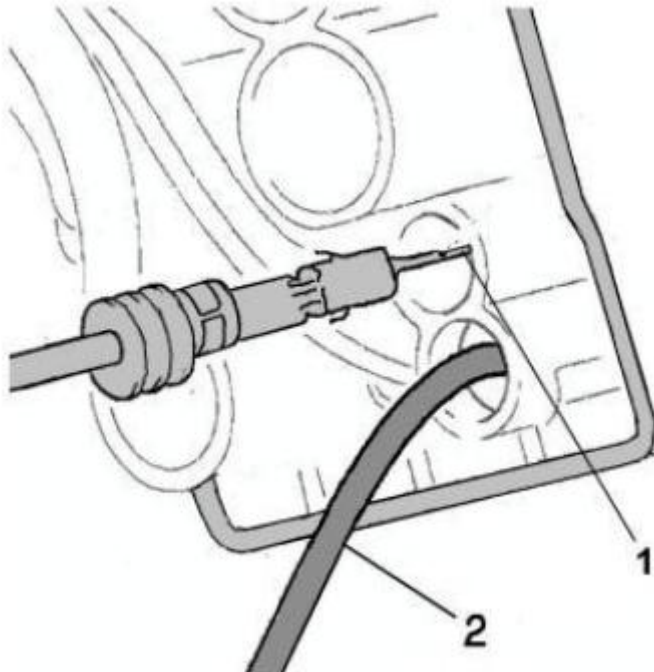

Picture 5

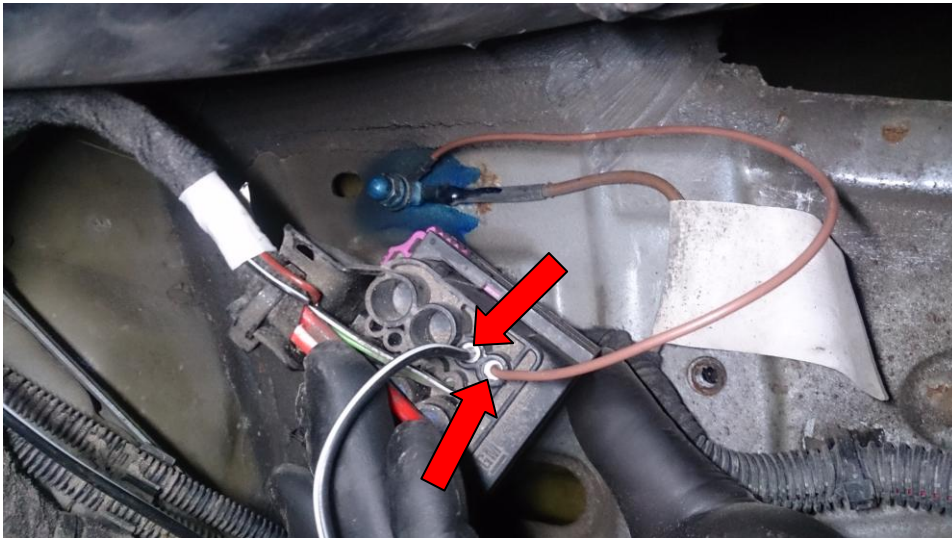

chamber 1 (1) - cable colour black/white
 chamber 2 (2) - cable colour brown

WARNING !

BEFORE CONNECTING THE COMPRESSOR, MAKE CERTAIN THAT THE POLARITY IS CORRECT.

18. Remove nut ground connection from the body.
19. Install ground cable (eye) from wiring harness plug X26 and tighten nut.
 - fasten cables with cable strap to plug
 - connect wiring harness plug
 - clip-in wiring harness plug to bracket
20. Fasten cables with insulating tape to wiring harness
21. Install wheel housing protective paneling.

- 22. Install front wheel.
- 23. Install relay (2) and fuse (1) (Picture 6)

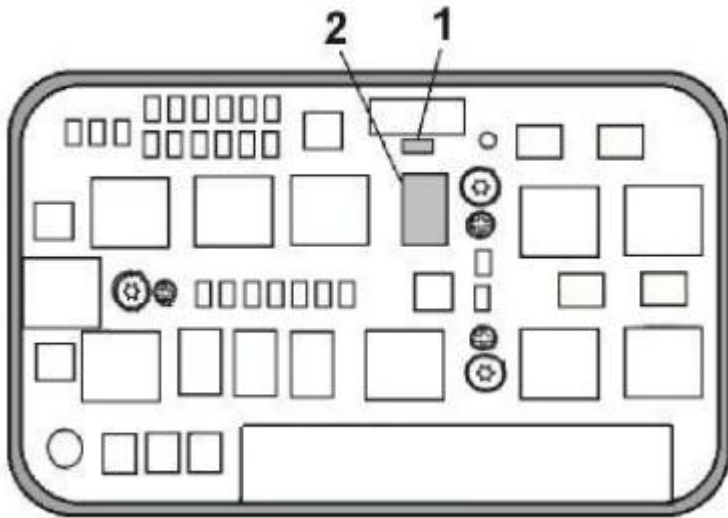

Picture 6

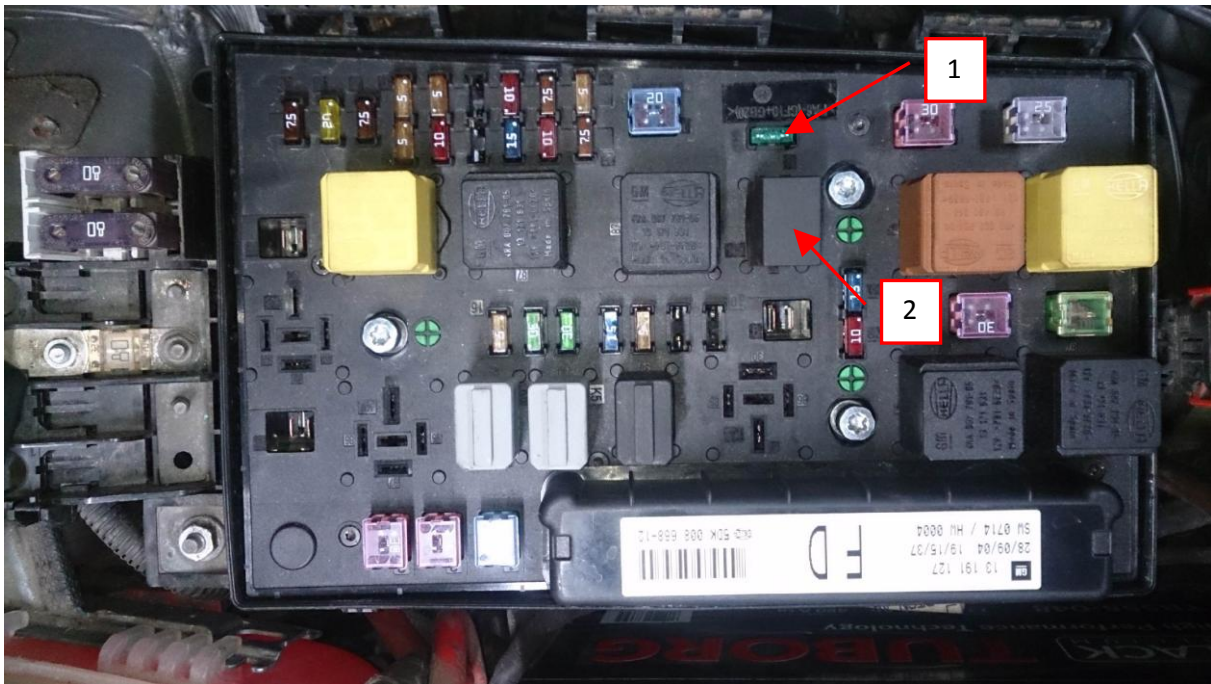

24. Install engine compartment electronic module (UEC).

Important

Pull positioning pins (2) down to the stop with a suitable tool. Tighten 3x screw (1) (Picture 7).

Note

Positioning pins must be visible again in mounted position

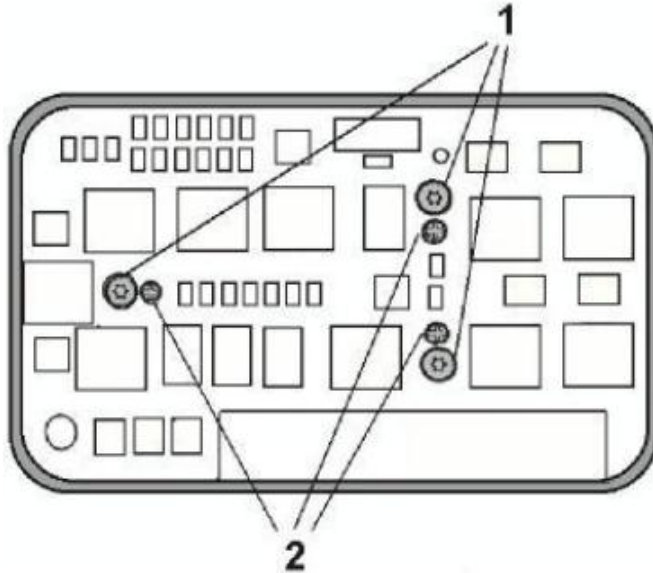

Picture 7

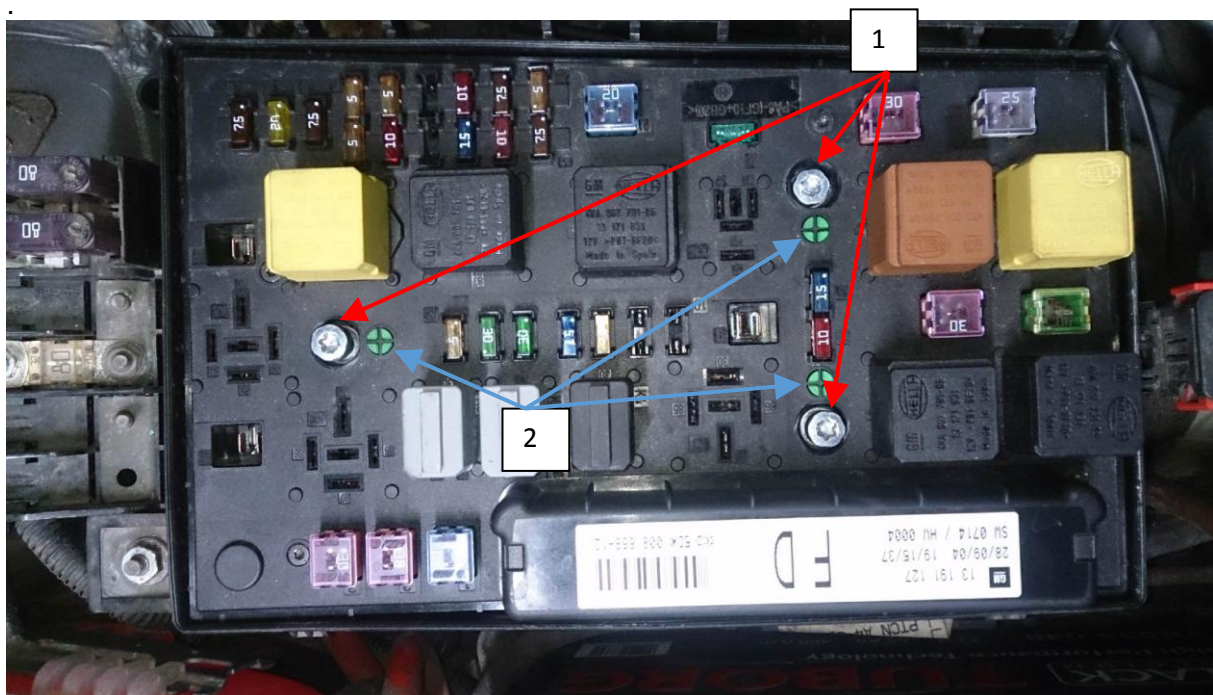

25. Reprogram engine control unit, ECC and UEC. For the ECU, (variant programming), select "unregulated AC", for the ECC select "compressor with clutch" for the UEC select "ECC not present".

26. Check air conditioning function.

27. Erase trouble codes.